

MO3030,MO3036,MO3042

ASSEMBLY INSTUCTIONS

Getting started:

Prepare a solid surface with protection layer to assemble on.

STEP 1: Join side panel with back panel.

STEP 2: Join side panels with back panel and attach top panel for support.

STEP 3: Join bottom panel with side panels and back panel.

STEP 4: Attach face-frame on.

STEP 5: Fix door onto the face-frame and adjust the cover-space.

| PARTS LIST | | |
|------------|------------------|-----|
| NO. | Description | QTY |
| 1 | FACE FRAME | 1 |
| 2 | BACK PANEL | 1 |
| 3 | SIDE PANEL | 2 |
| 4 | ADJUSTABLE SHELF | 1 |
| 5 | TOP&BOTTOM PANEL | 2 |
| 6 | CABINETS DOOR | 2 |

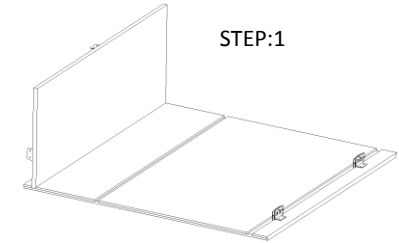
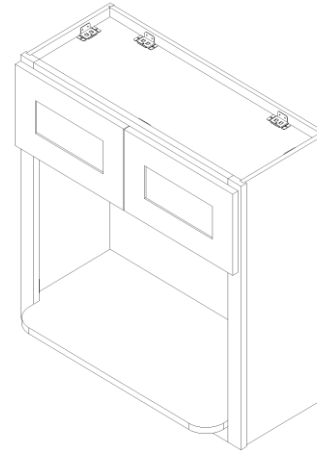

STEP:1

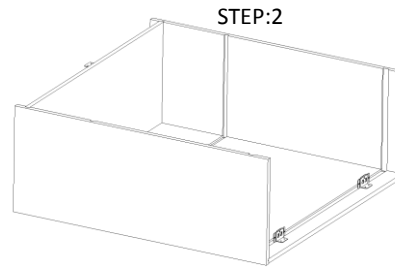

STEP:2

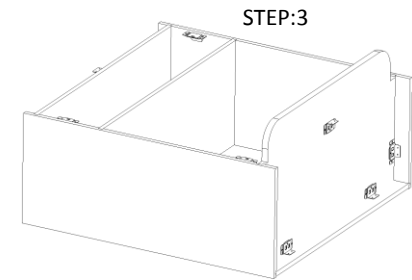

STEP:3

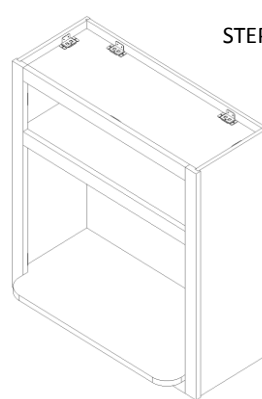



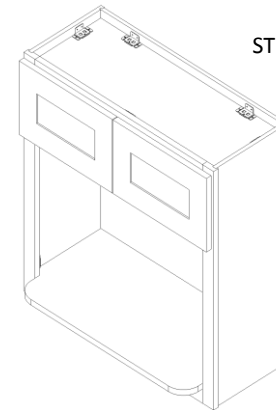



STEP:4

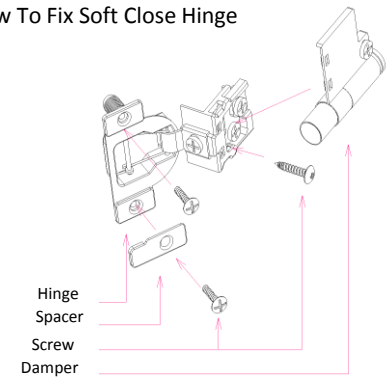

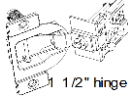
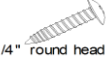
STEP:5

How To Fix Soft Close Hinge



| 7 | 1 1/2" SOFTCLOSE HINGE | 4 |  1 1/2" hinge |
|-----|-------------------------------|-----|---|
| 6 | 3/4" ROUND HEAD SCREW | 4 |  3/4" round head screw |
| 5 | BUMPER | 4 |  Bumper |
| 4 | DAMPER | 2 |  Damper |
| 3 | 9/16"ROUND HEAD SCREW | 95 |  9/16" round head screw |
| 2 | CLEAT AND BUCKLE | 19 |  Cleat and Buckle |
| 1 | 1"FLAT HEAD SCREW FOR CARCASS | 12 |  1" flat head screw |
| NO. | Description | QTY | PICTURE |

HARDWARE LIST