

LSB33,LSB36

ASSEMBLY INSTRUCTIONS

Getting started:

prepare a protection layer, a screwdriver

STEP 1: Join right side panel with right back panel.

STEP 2: Fix the bottom panel on.

STEP 3: Join left side panel with left back panel.

STEP 4: Attach toe-kick on.

STEP 5: Stand cabinet up.

STEP 6: Attach face-frame(long and short) together, then attach to side and bottom panels.

STEP 7: Attach top cross brace using screws.



STEP 8: Insert back panel through the groove.

STEP 9: Install the wooden corner blocks.

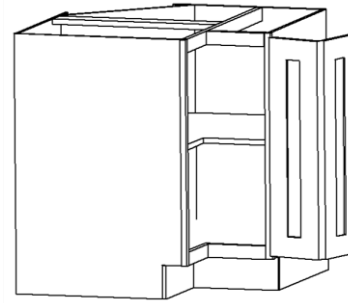
STEP 10 Fix the door onto the face-frame and adjust the cover-space.

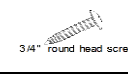
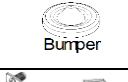
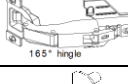
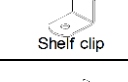
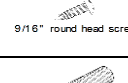
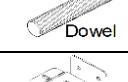
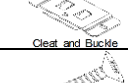

PARTS LIST		
NO.	Description	QTY
1	FACE FRAME	1
2	FACE FRAME	1
3	BACK PANEL	1
4	BACK PANEL	2
5	ADJUSTABLE SHELF	1
6	TOP&BOTTOM PANEL	1
7	CONNECT STRIP	1
8	SIDE PANEL	2
9	TOE KICK	1
10	TOE KICK	1
11	CABINETS DOOR	2

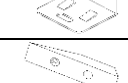
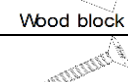
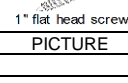
12	1 1/2" SOFTCLOSE HINGE	2	
11	3/4" ROUND HEAD SCREW	8	
10	BUMPER	4	
9	165 DEGREE HINGLE	2	
8	SHELF CLIP	6	
7	9/16"ROUND HEAD SCREW	88	
6	DOWEL	6	
5	CLEAT AND BUCKLE	17	
4	1"FLAT HEAD SCREW FOR CARCASS	11	
3	BUCKLE	1	
2	WOOD BLOCK	4	
1	1" FLAT HEAD SCREW FOR WOOD BLOCK	8	

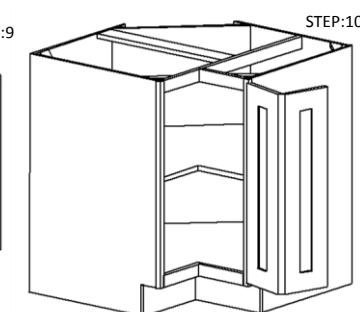
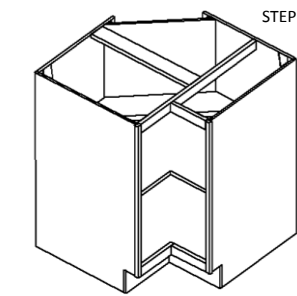
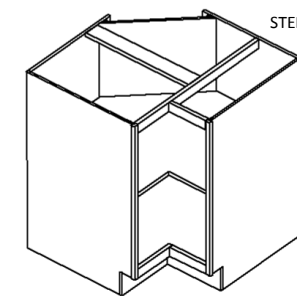
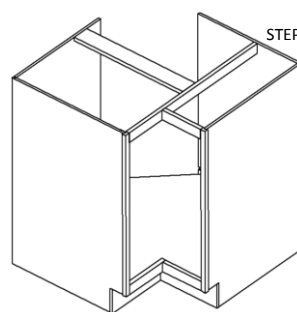
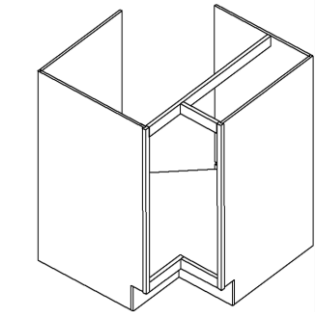
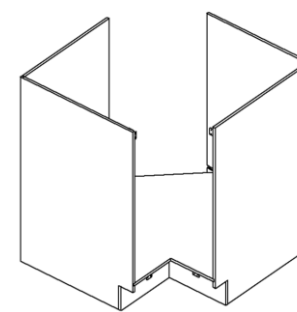
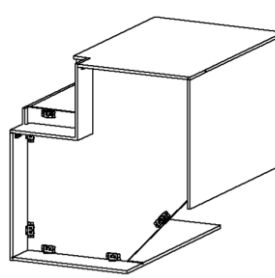
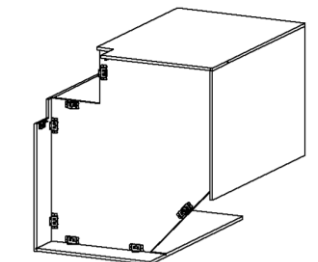
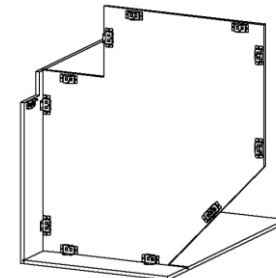
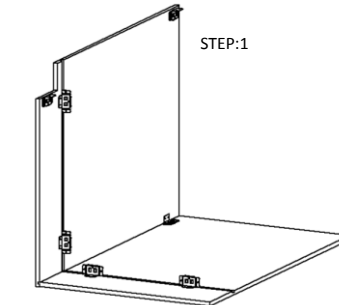

NO.	Description	QTY	PICTURE
-----	-------------	-----	---------

HARDWARE LIST