

**AW1230,AW1236,AW1242**

**ASSEMBLY INSTRUCTIONS**

**Getting started:**

Prepare a solid surface with protection layer to assemble on.

STEP 1: Join top and bottom panel with side panel.

STEP 2: Attach left side panel.





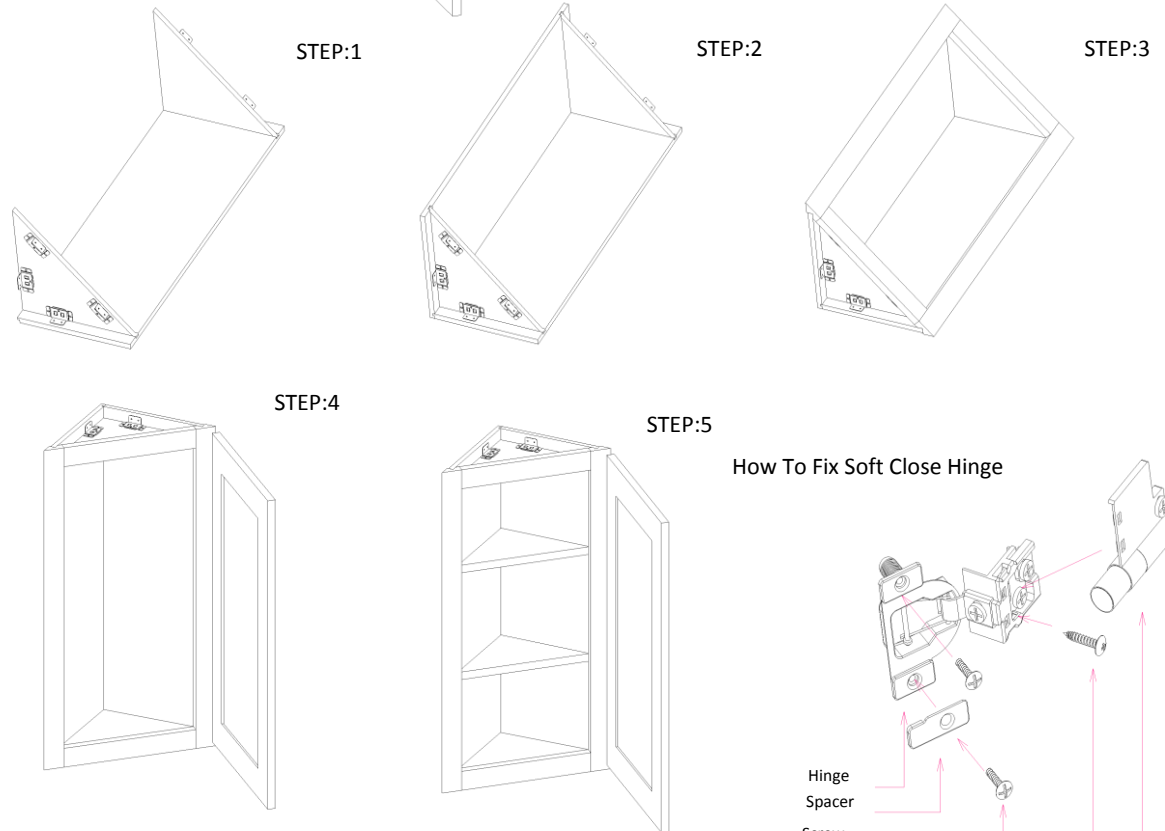
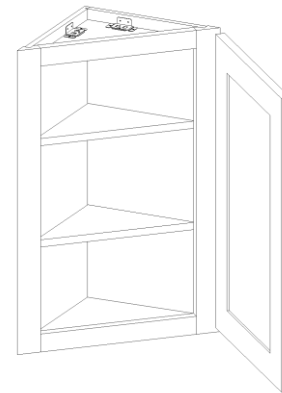

STEP 3: Attach the face-frame.

STEP 4: Fix the door to the face-frame and adjust the cover-space.

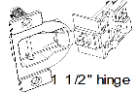
STEP 5: Put in the adjustable shelves.

PARTS LIST		
NO.	Description	QTY
1	RIGHT SIDE PANEL	1
2	LEFT SIDE PANEL	1
3	FACE FRAME	1
4	TOP&BOTTOM PANEL	2
5	ADJUSTABLE SHELF	2 OR 3
6	CABINETS DOOR	1

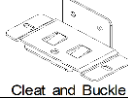

7	1 1/2" SOFTCLOSE HINGE	2	
6	3/4" ROUND HEAD SCREW	2	
5	BUMPER	2	
4	DAMPER	1	
3	SHELF CLIP	8 OR 12	
2	9/16"ROUND HEAD SCREW	40	
1	CLEAT AND BUCKLE	8	
NO.	Description	QTY	PICTURE

**HARDWARE LIST**

**How To Fix Soft Close Hinge**

