

# SB36

## ASSEMBLY INSTUCTIONS

Getting started:

Prepare a solid surface with protection layer to assemble on.

STEP 1: Join side panel with back panel.

STEP 2: Join bottom panel with side panel.

STEP 3: Join side panel with bottom and back panel.







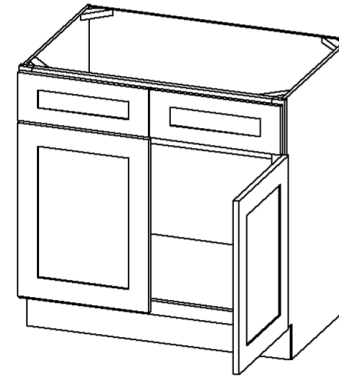

STEP 4: Attach face-frame and toekick board.

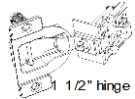
STEP 5: Attach the wooden corner blocks on the top corners.

STEP 6: Fix doors and drawer heads onto the face-frame and adjust the cover-space.

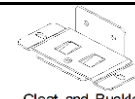

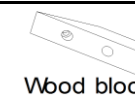
PARTS LIST		
NO.	Description	QTY
1	FACE FRAME	1
2	BACK PANEL	1
3	TOP&BOTTOM PANEL	1
4	SIDE PANEL	2
5	TOE KICK	1
6	CABINETS DOOR	2
7	DRAWER HEAD	2

9	1 1/2" SOFTCLOSE HINGE	4	
8	3/4" ROUND HEAD SCREW	4	
7	BUMPER	4	
6	DAMPER	2	
5	9/16" ROUND HEAD SCREW	55	
4	CLEAT AND BUCKLE	11	
3	1" FLAT HEAD SCREW FOR CARCASS	4	
2	WOOD BLOCK	4	
1	1" FLAT HEAD SCREW FOR WOOD BLOCK	8	
NO.	Description	QTY	PICTURE

### HARDWARE LIST

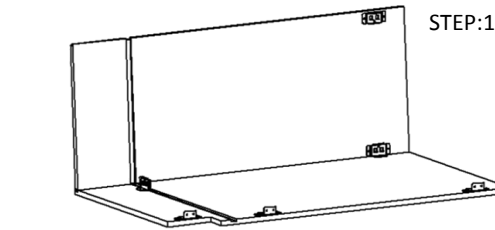

STEP:1

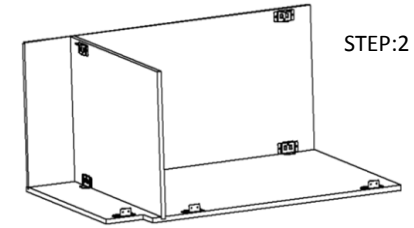

STEP:2

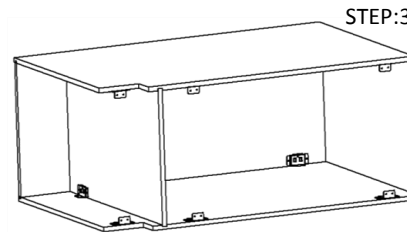

STEP:3

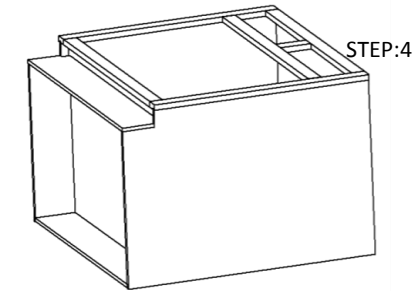

STEP:4

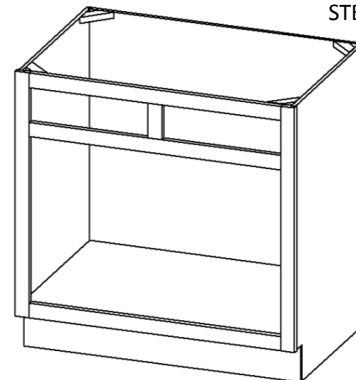

STEP:5

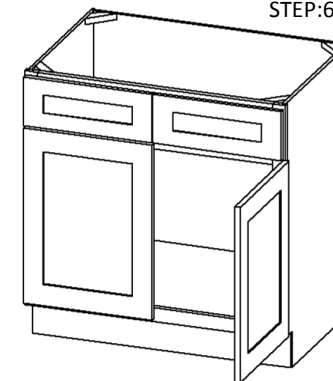

STEP:6

How To Fix Soft Close Hinge

