









# PART LIST

NO.	Picture	Specification	Qty
A		Screws $\text{Ø}3 \times 1/2$ "	40
B		Screws $\text{Ø}4 \times 1$ "	6
C		Metal Clip	10
D		Hinges	4
E		Screws $\text{Ø}4 \times 3/4$ "	4
F		Screws $\text{Ø}4 \times 5/8$ "	8



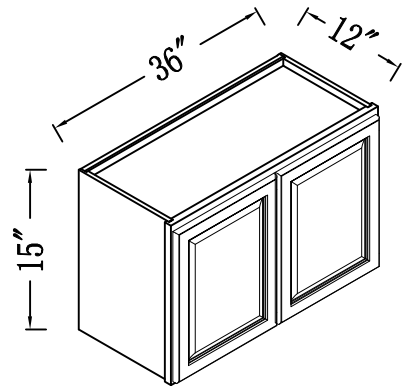

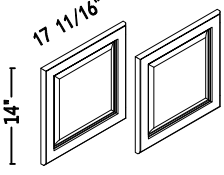
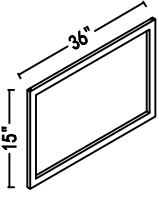
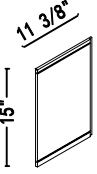

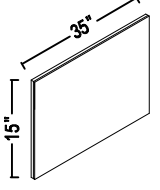
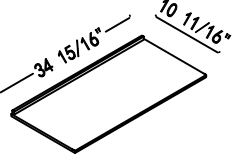
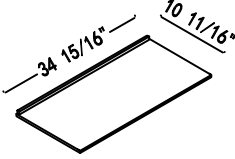

W3615

Unit: inch

<p>1</p>  <p>Door</p>	<p>2</p>  <p>Face frame</p>	<p>3</p>  <p>Left Side Panel</p>	<p>4</p>  <p>Right Side Panel</p>	<p>5</p>  <p>Back board</p>
<p>6</p>  <p>Top Panel</p>	<p>7</p>  <p>Bottom Panel</p>			

# Assembly instructions

NO.	PICTURE	SIZE	QTY	NO.	PICTURE	SIZE	QTY
A		Screws $\text{Ø}3 \times 1/2''$	40	D		Hinges	4
B		Screws $\text{Ø}4 \times 1''$	6	E		Screws $\text{Ø}4 \times 3/4''$	4
C		Metal Clip	10	F		Screws $\text{Ø}4 \times 5/8''$	8

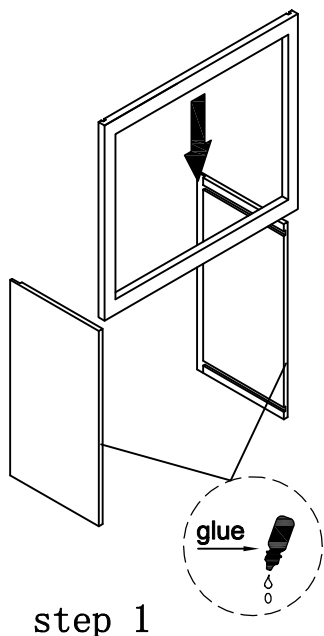

step 1

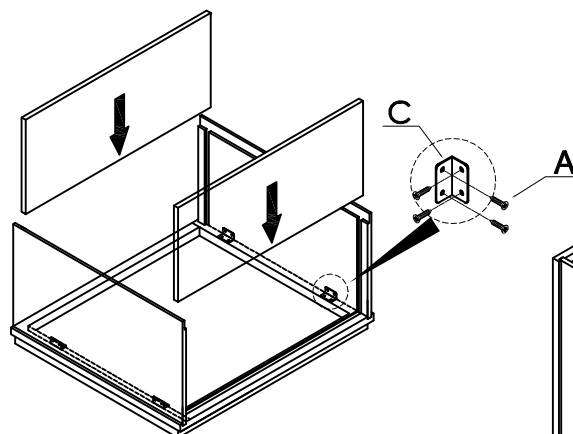

step 2

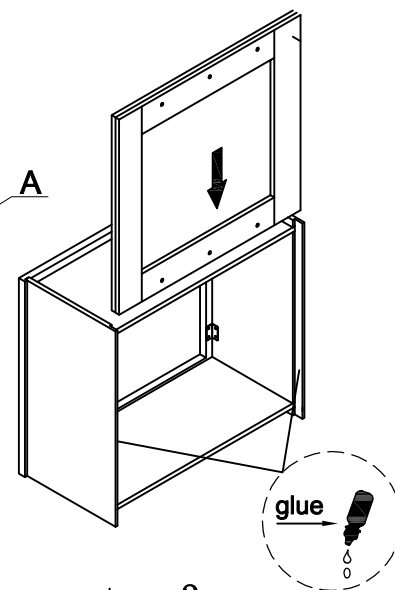

step 3

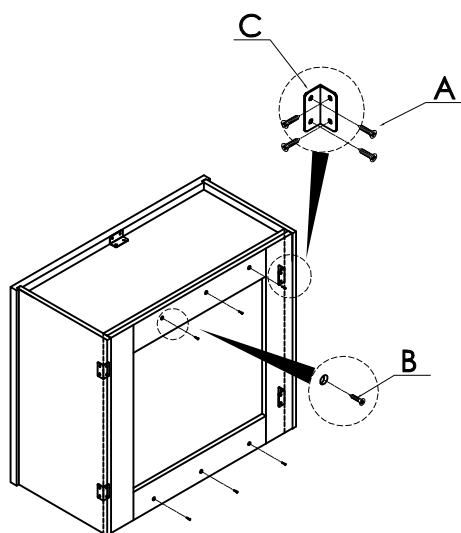

step 4

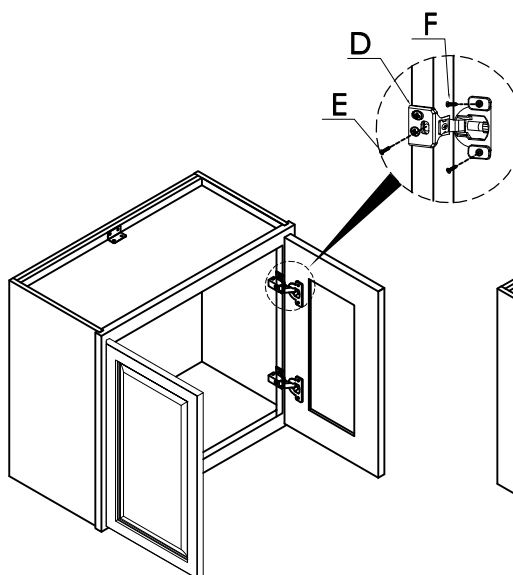

step 5

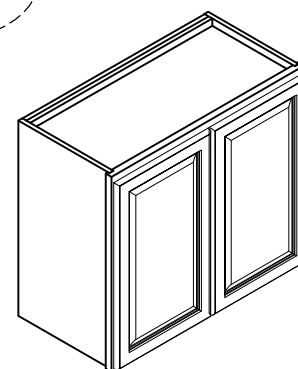

step 6